

Halolite Series

M03-11W

Optical Lens



Technical Parameters:

Name	Parameters
Light source:	COB
Input Voltage:	AC220~240V 50/60Hz
Current:	250mA
Rated life:	>50,000 hours
Operating temperature:	-20°C~40°C
Storage temperature:	-30°C~60°C
Certificate:	CE/RoHS
Dimmability:	Dimmable Optional
Weight:	0.19KG (M032) / 0.24KG (M0322) 0.28KG (M0323) / 0.29KG (M0324) 0.29KG (M0325) / 0.31KG (M0326)

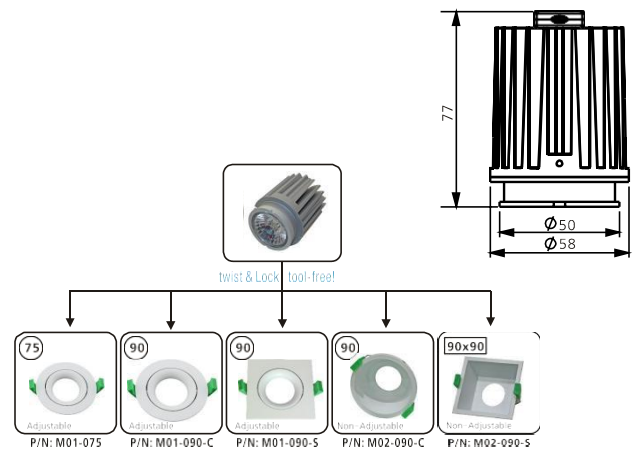

Ordering Information:

○ Silver gray

Power	CRI	Beam Angle	Luminous	CCT	Housing	Part Number	
11W	>80	15°	1190 lm	3000K		M032*-11W-830-S-15	
			1190 lm	4000K	○	M032*-11W-840-S-15	
		▲ 24°	1170 lm	3000K	○	M032*-11W-830-S-24	
			1180 lm	4000K	○	M032*-11W-840-S-24	
		▲ 38°	1180 lm	3000K	○	M032*-11W-830-S-38	
			1210 lm	4000K	○	M032*-11W-840-S-38	
	>90	▲ 60°		1200 lm	3000K		M032*-11W-830-S-60
				1220 lm	4000K	○	M032*-11W-840-S-60
		▲ 15°		1000 lm	3000K	○	M032*-11W-930-S-15
				1080 lm	4000K		M032*-11W-940-S-15
			▲ 24°	970 lm	3000K		M032*-11W-930-S-24
				1060 lm	4000K		M032*-11W-940-S-24
▲ 38°		970 lm	3000K		M032*-11W-930-S-38		
		1080 lm	4000K		M032*-11W-940-S-38		
▲ 60°		990 lm	3000K		M032*-11W-930-S-60		
		1090 lm	4000K		M032*-11W-940-S-60		

***: 1: S-MR16; 2: M01-075; 3: M01-090-C; 4: M01-090-S; 5: M02-090-C; 6: M02-090-S

LED Engines

Technical Data test pattern

CRI80 15°

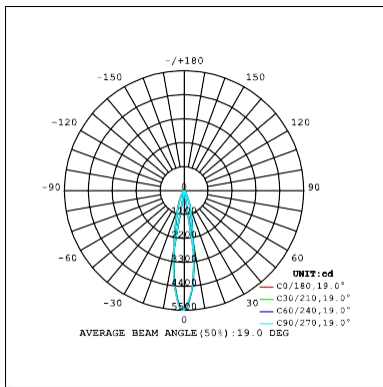

3000K

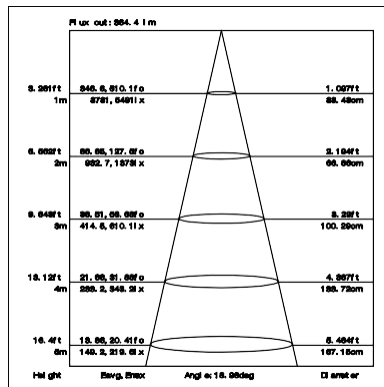

4000K

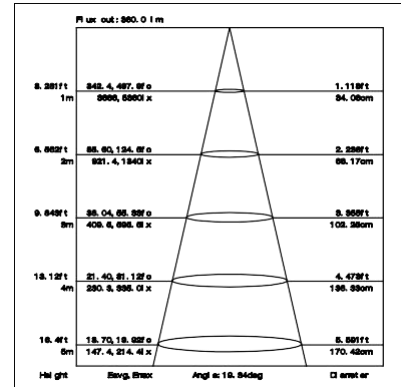

CRI80 24°

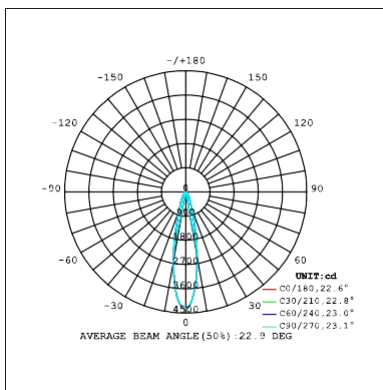

3000K

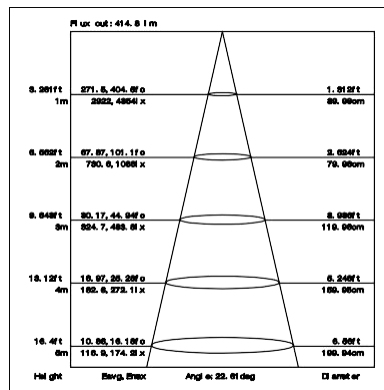

4000K

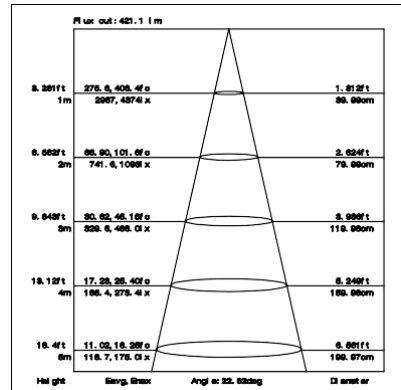

CRI80 38°

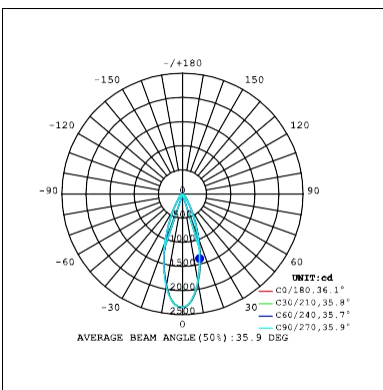

3000K

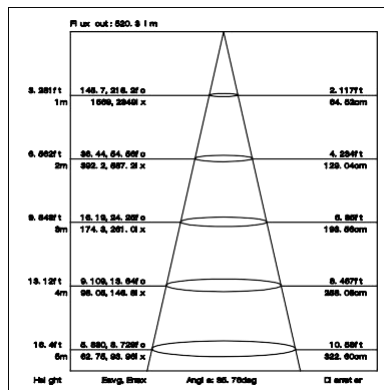

4000K

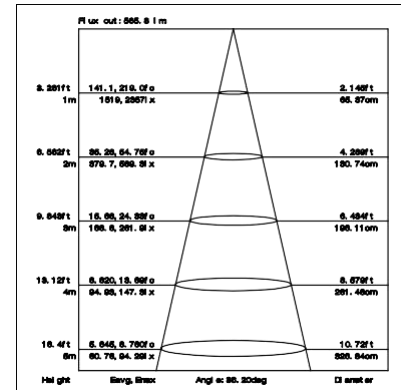

CRI80 60°

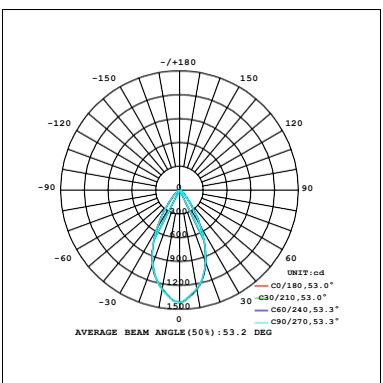

3000K

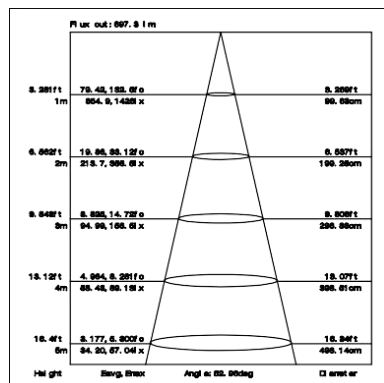

4000K

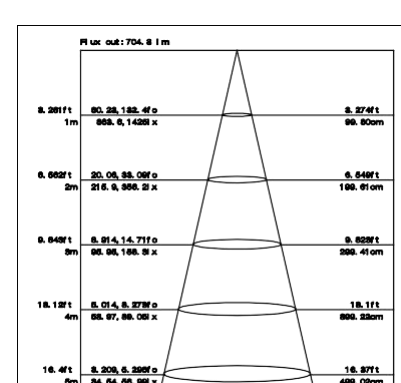

LED Engines

CRI90 15°

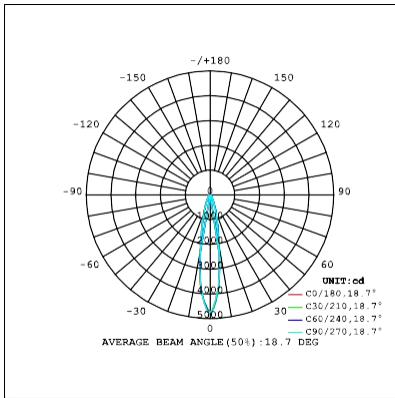

3000K

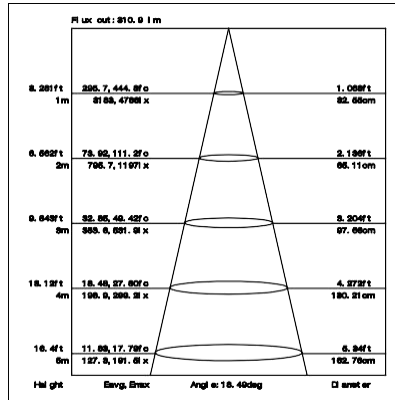

4000K

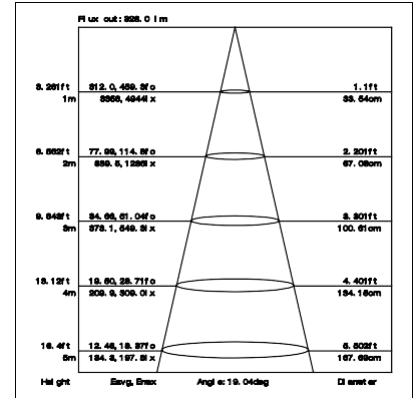

CRI90 24°

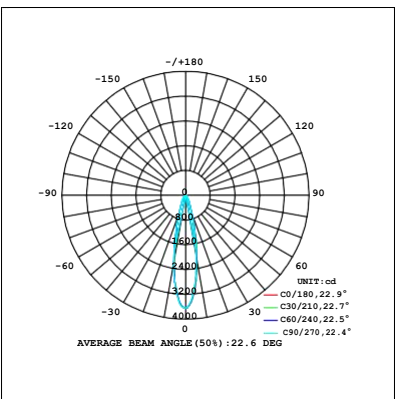

3000K

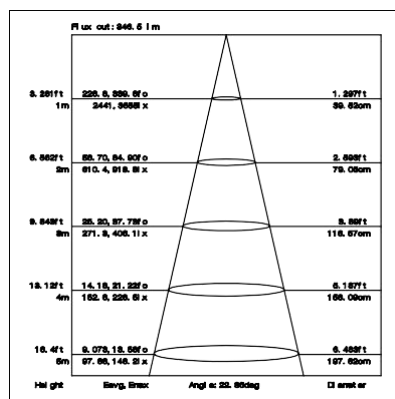

4000K

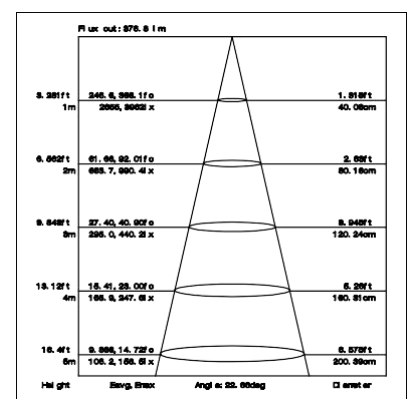

CRI90 38°

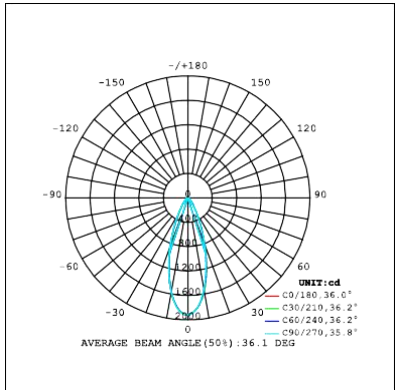

3000K

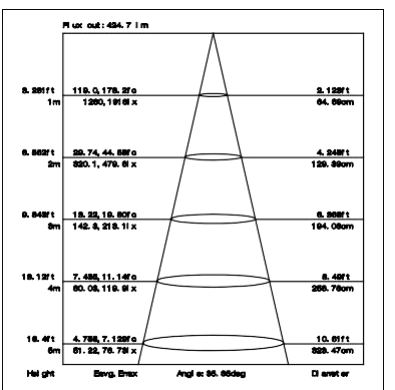

4000K

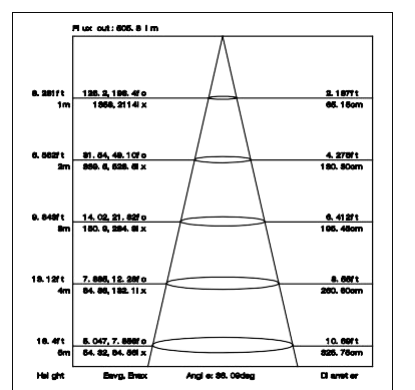

CRI90 60°

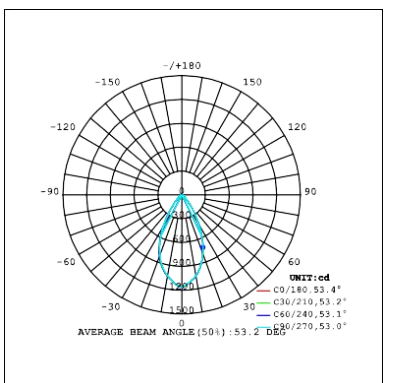

3000K

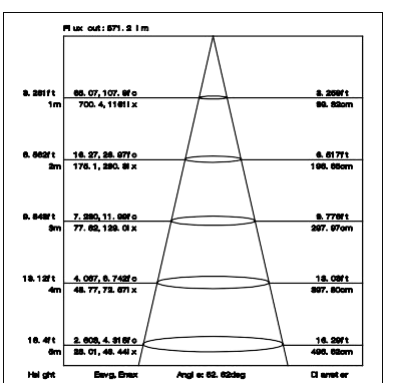

4000K

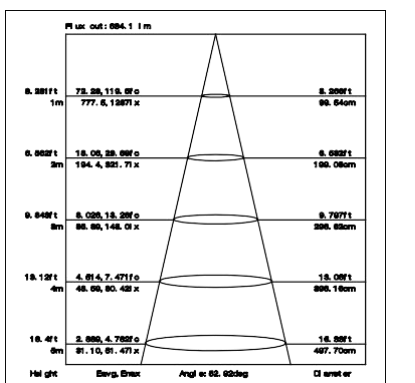

LED Engines

Installation instruction

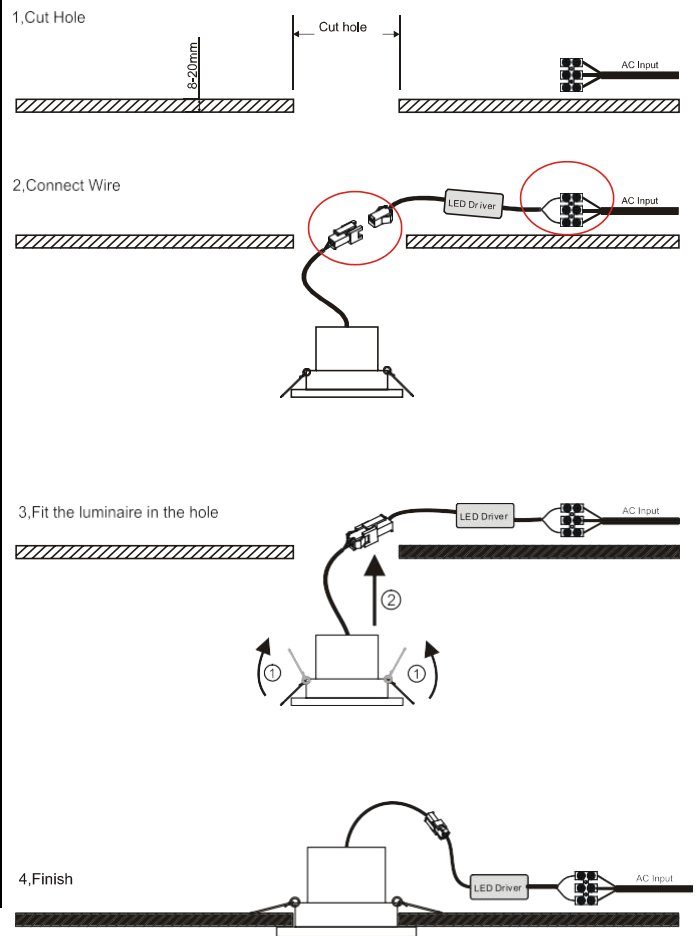
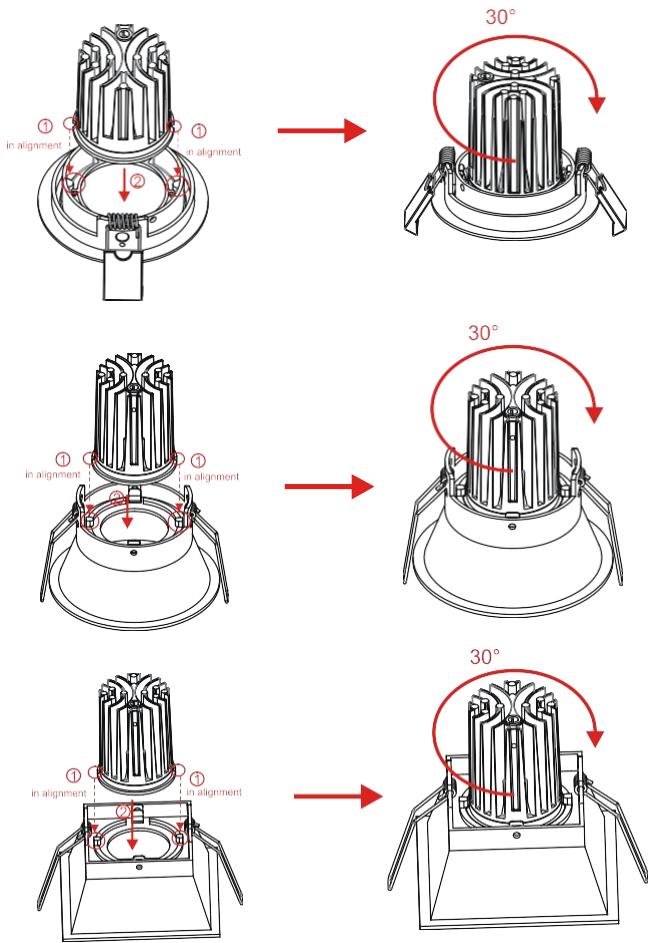

Packaging:

M012 (Without driver)

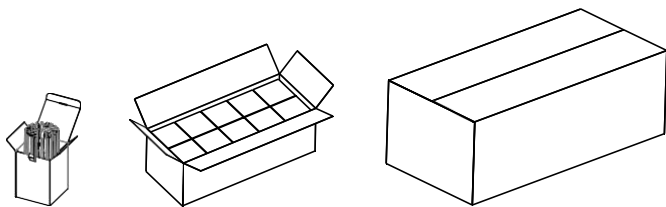

Box	Inner box	Outer carton
L52*W52*H76mm	L270*W110*H95mm	L600*W300*H230mm
1pc/box	10pc/box	100pcs/CTN
GW: 0.1kg/box	GW: 1.05kg/box	GW: 11.5kg/carton

M012 (With driver)

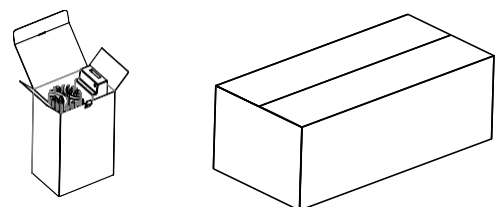

Box	Outer carton
L96*W65*H140mm	L600*W300*H230mm
1pc/box	36pcs/CTN
GW: 0.15kg/box	GW: 6.5kg/carton

LED Engines

M0122

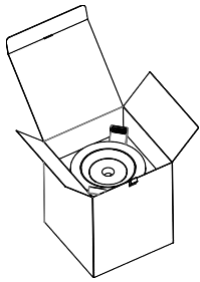

Box
 L105*W105*H130mm
 1pc/box
 GW: 0.25kg/box

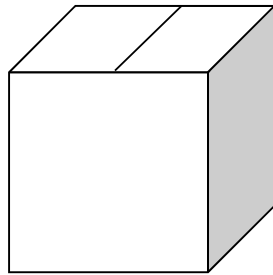

Outer carton
 L450*W450*H410mm
 48pcs/CTN
 GW: 14kg/carton

M0123

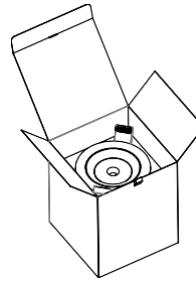

Box
 L105*W105*H130mm
 1pc/box
 GW: 0.3kg/box

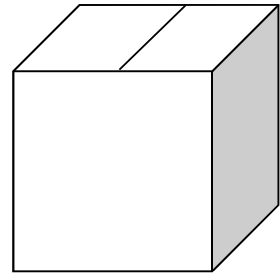

Outer carton
 L450*W450*H410mm
 48pcs/CTN
 GW: 16kg/carton

M0124/M0126

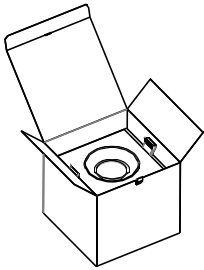

Box
 L130*W130*H120mm
 1pc/box
 GW: 0.35kg/box

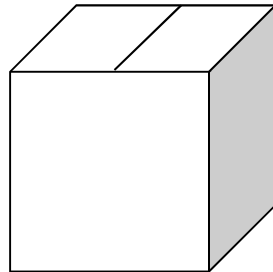

Outer carton
 L540*W420*H280mm
 24pcs/CTN
 GW: 9.5kg/carton

M0125

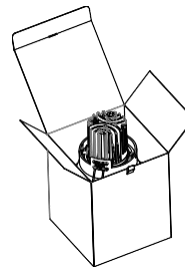

Box
 L105*W105*H130mm
 1pc/box
 GW: 0.3kg/box

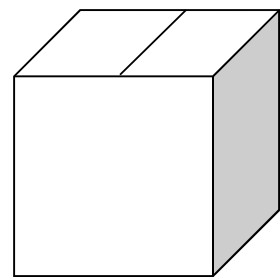

Outer carton
 L450*W450*H410mm
 48pcs/CTN
 GW: 16kg/carton

Product naming system

