

IMSSeries

IMS-BL100 15W / 20W

Reflector +Lens

Technical Parameters:

Name	Parameters	
Lightsource:	COB	
InputVoltage:	AC220~240V 50/60Hz	
Current:(Adjustable)	350mA	500mA
	15W	20W
Ratedlife:	>50,000 hours	
Operatingtemperature:	-20°C~40°C	
Storage temperature:	-30°C~60°C	
Certificate:		
Dimmability:	DimmableOptional	

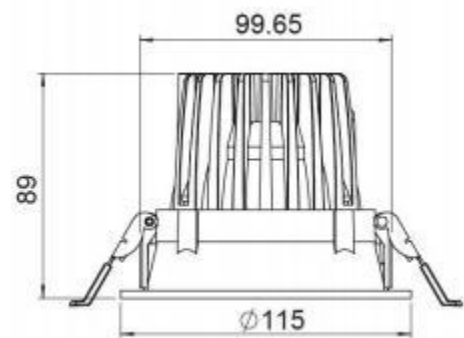

Ordering Information:

● Silver gray

Power	CRI	BeamAngle	Luminous	CCT	Housing	PartNumber
15W	80	▲ 15°	1690 lm	3000K	●	IMS-BL100-15W-830-S-15
			1700 lm	4000K	●	IMS-BL100-15W-840-S-15
		▲ 28°	1695 lm	3000K	●	IMS-BL100-15W-830-S-28
			1710 lm	4000K	●	IMS-BL100-15W-840-S-28
		▲ 36°	1690 lm	3000K	●	IMS-BL100-15W-830-S-36
			1706 lm	4000K	●	IMS-BL100-15W-840-S-36
	>90	▲ 15°	1394 lm	3000K	●	IMS-BL100-15W-930-S-15
			1386 lm	3000K	●	IMS-BL100-15W-930-S-28
		▲ 28°	1396 lm	3000K	●	IMS-BL100-15W-930-S-36
			1396 lm	3000K	●	IMS-BL100-15W-930-S-36
		▲ 36°	1396 lm	3000K	●	IMS-BL100-15W-930-S-36
			1396 lm	3000K	●	IMS-BL100-15W-930-S-36
20W	>80	▲ 15°	2180 lm	3000K	●	IMS-BL100-20W-830-S-15
			2190 lm	4000K	●	IMS-BL100-20W-840-S-15
		▲ 28°	2180 lm	3000K	●	IMS-BL100-20W-830-S-28
			2188 lm	4000K	●	IMS-BL100-20W-840-S-28
		▲ 36°	2185 lm	3000K	●	IMS-BL100-20W-830-S-36
			2192 lm	4000K	●	IMS-BL100-20W-840-S-36
	>90	▲ 15°	1805 lm	3000K	●	IMS-BL100-20W-930-S-15
			1795 lm	3000K	●	IMS-BL100-20W-930-S-28
		▲ 28°	1795 lm	3000K	●	IMS-BL100-20W-930-S-28
			1798 lm	3000K	●	IMS-BL100-20W-930-S-36
		▲ 36°	1798 lm	3000K	●	IMS-BL100-20W-930-S-36
			1798 lm	3000K	●	IMS-BL100-20W-930-S-36



Technical Data test pattern

15W CRI80 15°

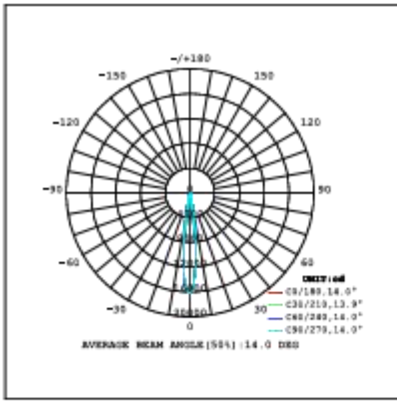

3000K

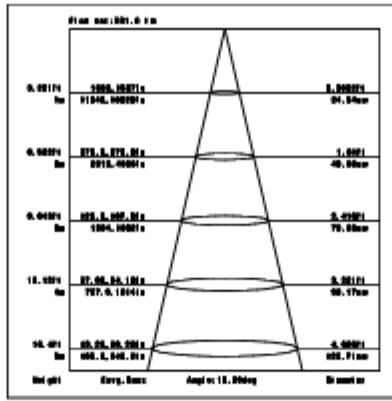

4000K

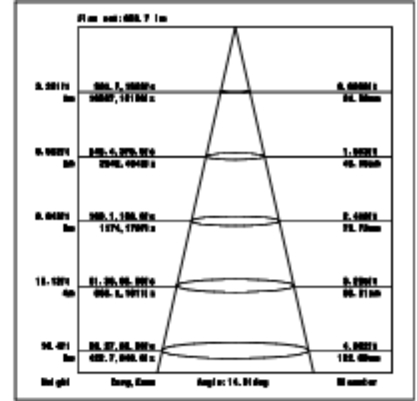

15W CRI80 28°

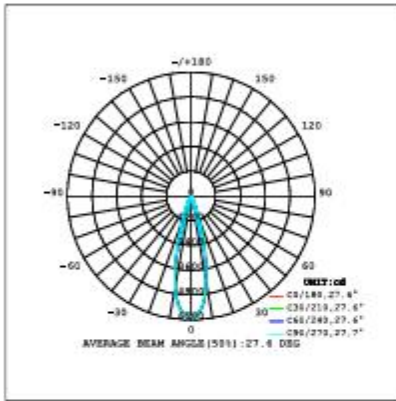

3000K

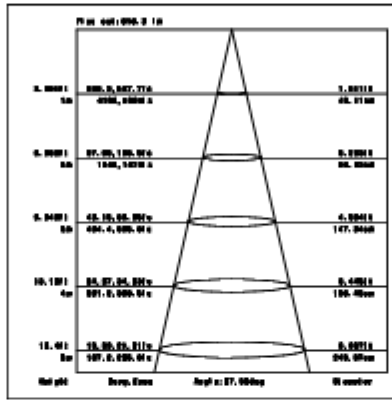

4000K

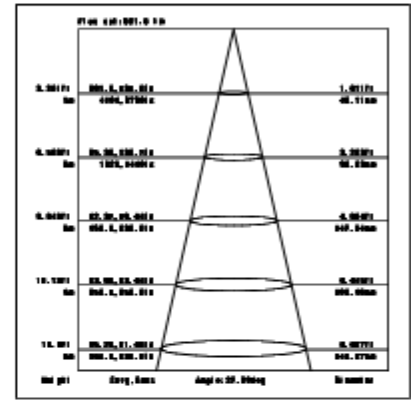

15W CRI80 36°

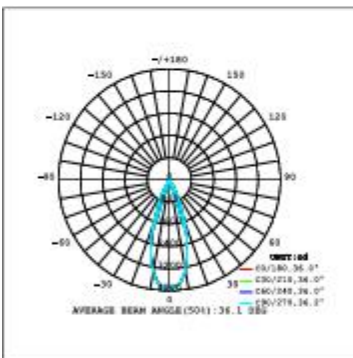

3000K

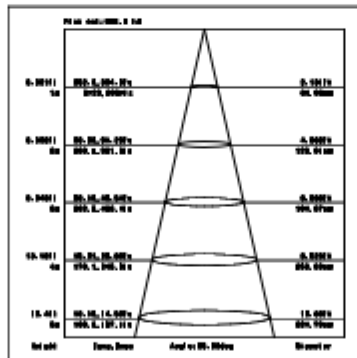

4000K

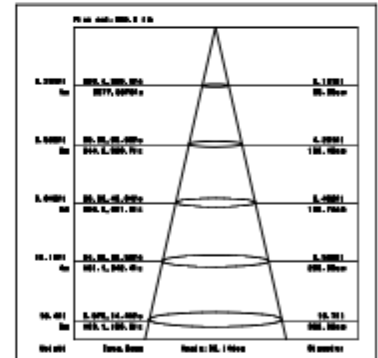

15W CRI90 15°

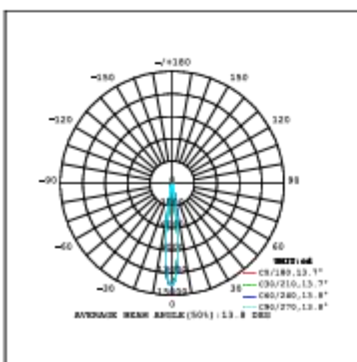

3000K

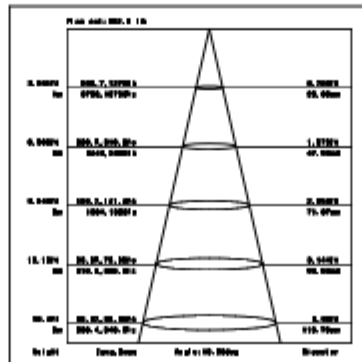

4000K

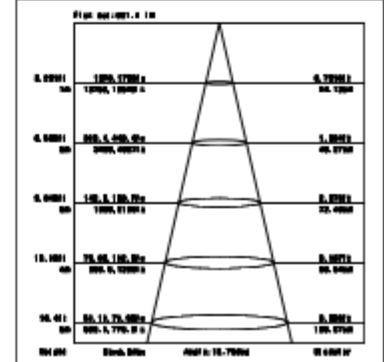

15W CRI90 28°

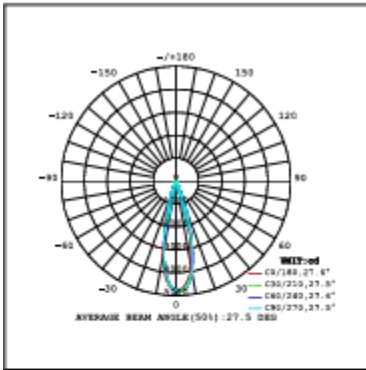

3000K

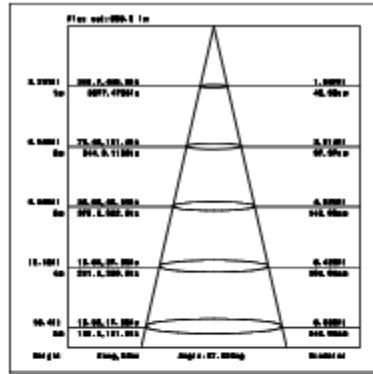

4000K

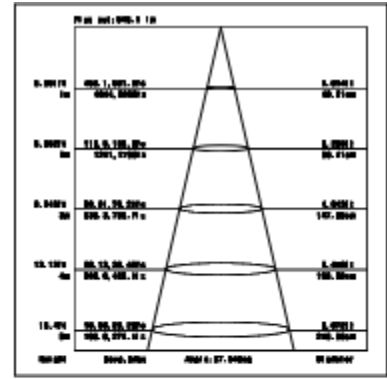

15W CRI90 36°

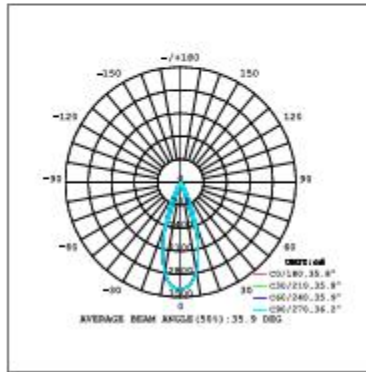

3000K

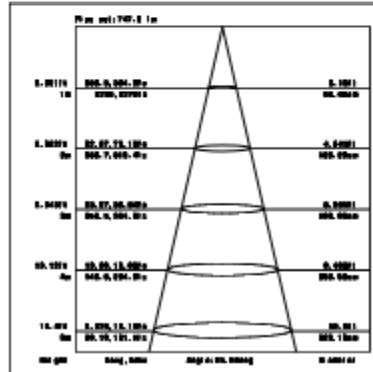

4000K

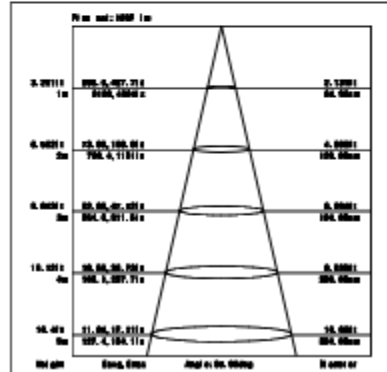

20W CRI80 15°

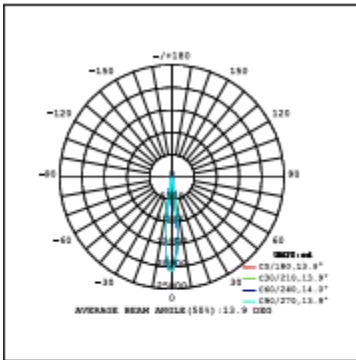

3000K

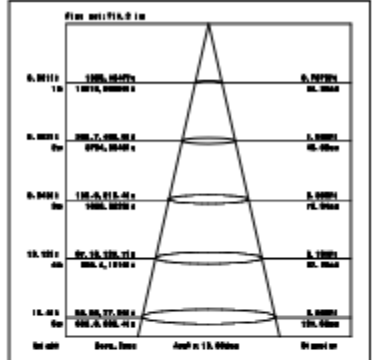

4000K

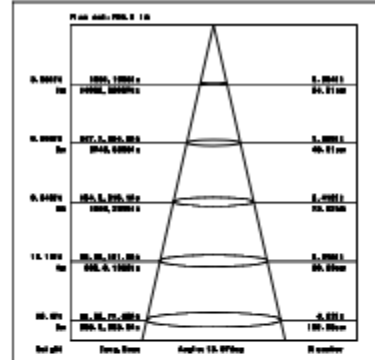

20W CRI80 28°

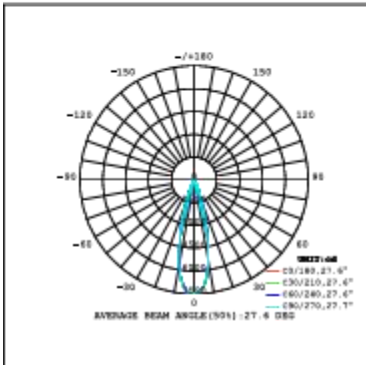

3000K

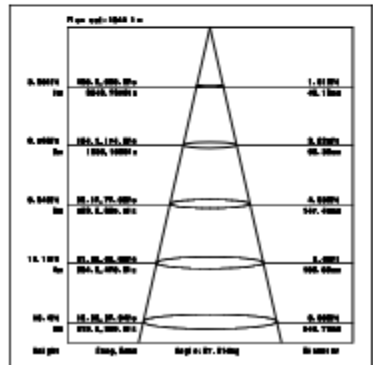

4000K

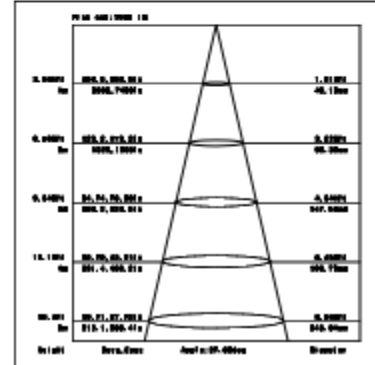

Installation instruction

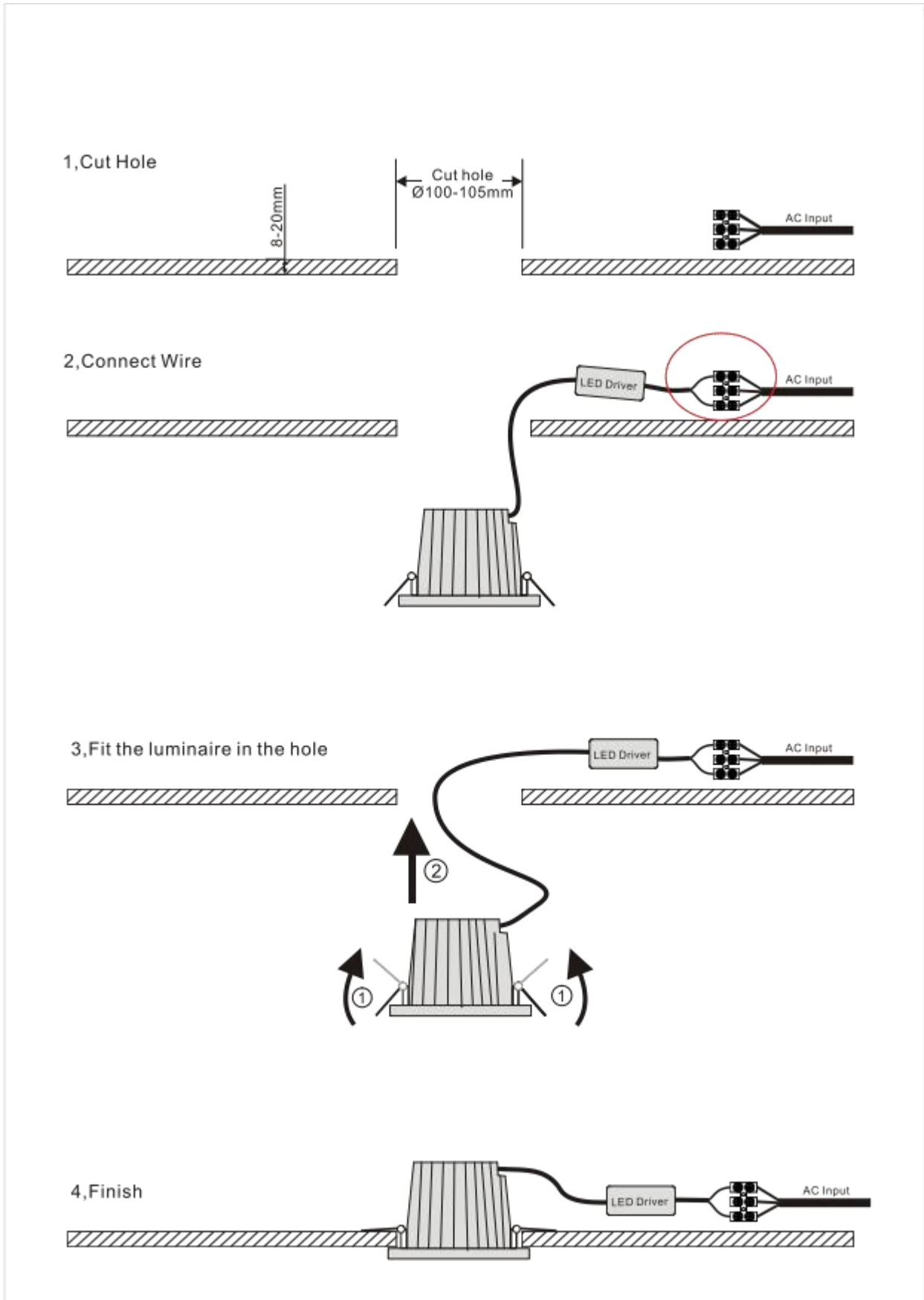

Packaging:

IMS-BL100 (With driver)

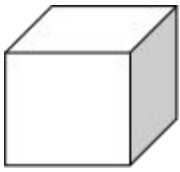

Box

L140W140*H155mm
1pc/box
GW: 0.4kg/box

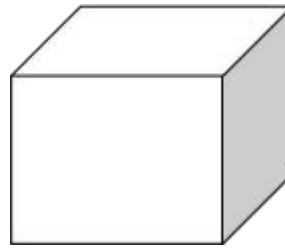

Outer carton

L720*W295*H328mm
20pcs/CTN
GW: 9kg/carton

Product naming system

M (X)XX X (X)– XW – X XX – X- XX

