

FLOW.IT Series

**DL31-S-15W**

optical lens

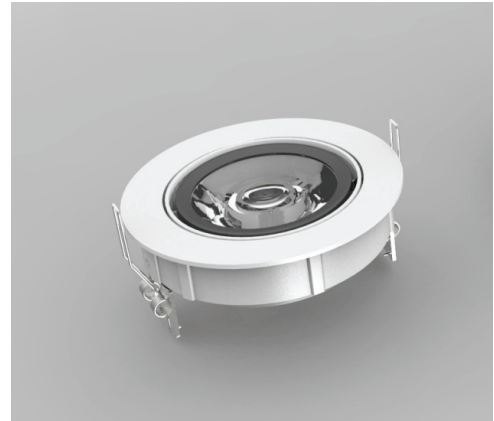

Technical Parameters:

Name	Parameters
Light source:	COB
Input Voltage:	AC220~240V 50/60Hz
LED Current:	350mA, 35-37V
Beam Angle:	12°/24°/36°/60°
Life Time:	> 50,000h - L80 - B10 (Ta 25° C)
Operating temperature:	-20°C~40°C
Certificate:	CE/RoHS
Weight:	0.35kg

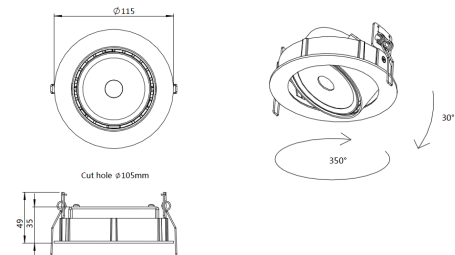

Ordering Information:

○ White ● Black

Power	CRI	Beam Angle	Luminous	CCT	Housing	Part Number
15W	>80	▲ 12°	1500 lm	3000K	○	DL311-15W-830-W-12-S
					●	DL311-15W-830-B-12-S
		▲ 24°	1600 lm	4000K	○	DL311-15W-840-W-12-S
					●	DL311-15W-840-B-12-S
		▲ 36°	1480 lm	3000K	○	DL311-15W-830-W-24-S
					●	DL311-15W-830-B-24-S
	>90	▲ 12°	1580 lm	4000K	○	DL311-15W-840-W-24-S
					●	DL311-15W-840-B-24-S
		▲ 24°	1520 lm	3000K	○	DL311-15W-830-W-36-S
					●	DL311-15W-830-B-36-S
		▲ 36°	1650 lm	4000K	○	DL311-15W-840-W-36-S
					●	DL311-15W-840-B-36-S
				○	DL311-15W-930-W-12-S	
				●	DL311-15W-930-B-12-S	
				○	DL311-15W-930-W-24-S	
				●	DL311-15W-930-B-24-S	
				○	DL311-15W-930-W-36-S	
				●	DL311-15W-930-B-36-S	

Technical Data test pattern

CRI80 12°

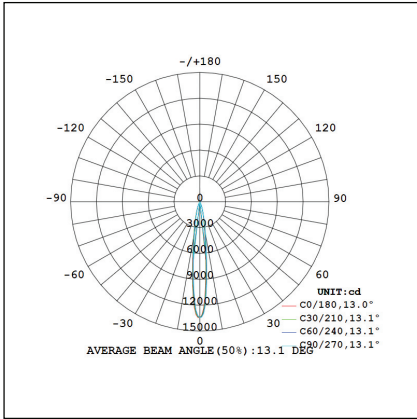

3000K

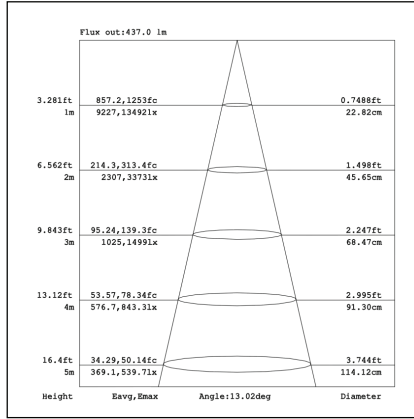

4000K

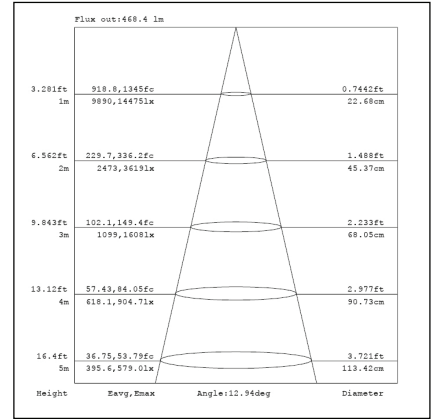

CRI80 24°

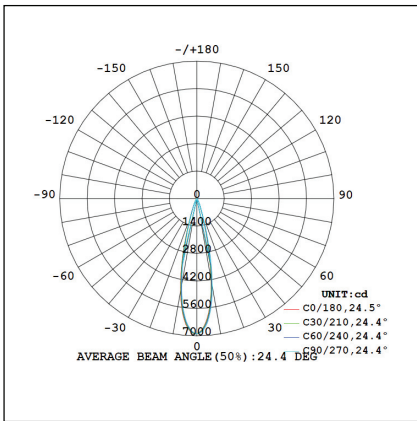

3000K

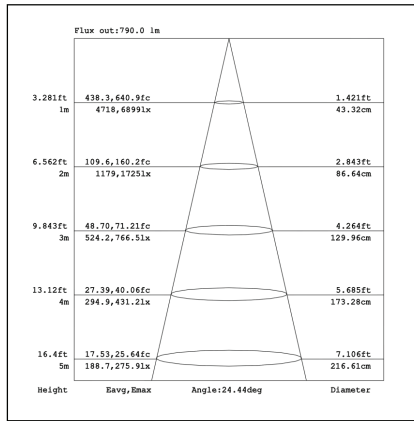

4000K

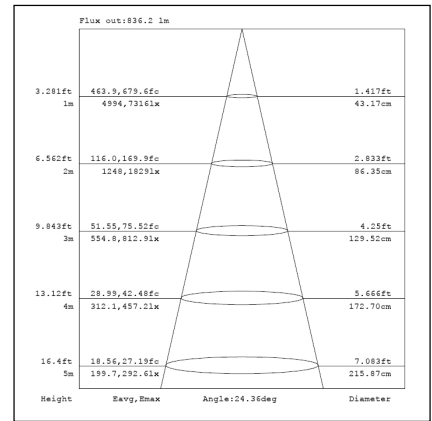

CRI80 36°

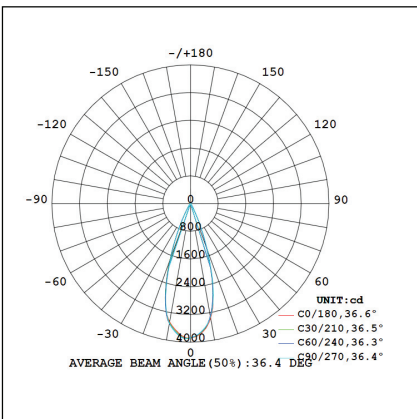

3000K

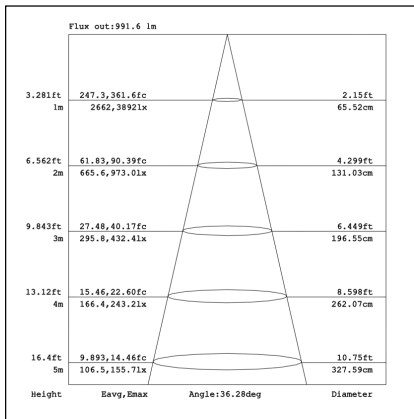

4000K

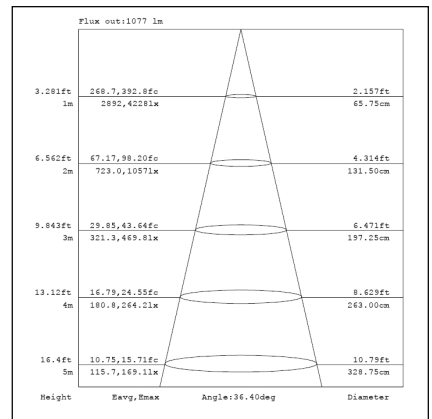

**CRI90 12°**

**3000K**

**4000K**

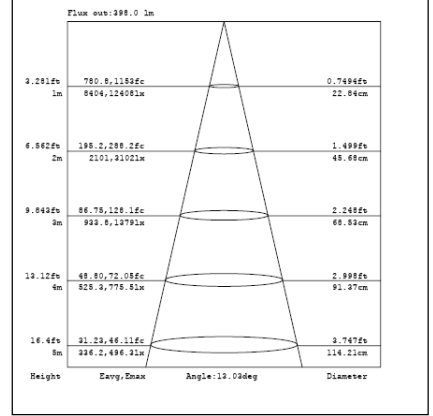
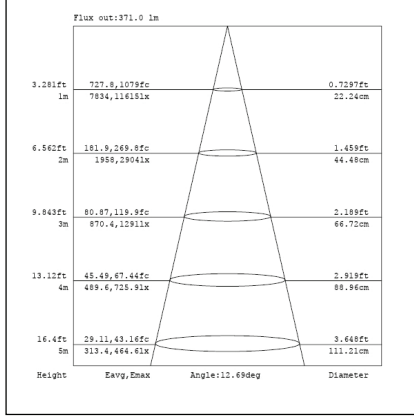
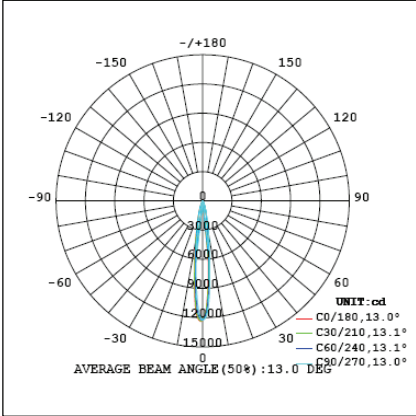

**CRI90 24°**

**3000K**

**4000K**

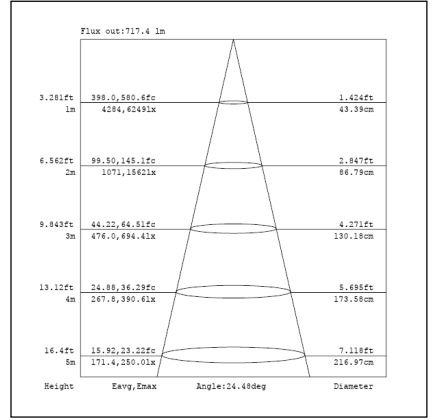
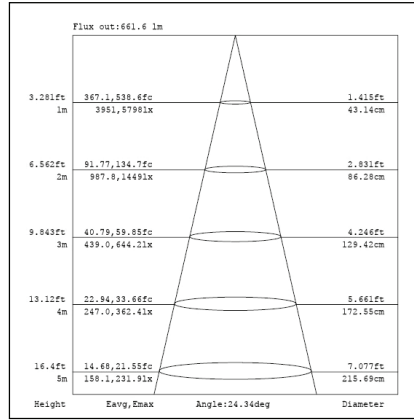
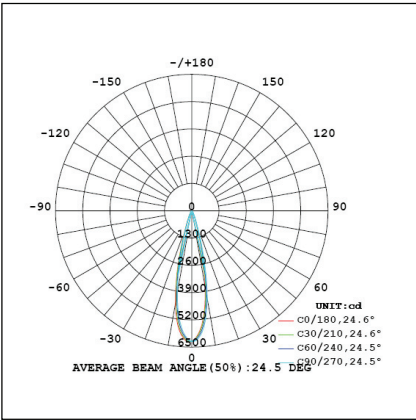

**CRI90 36°**

**3000K**

**4000K**

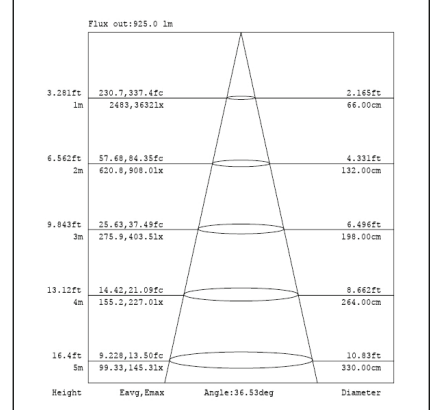
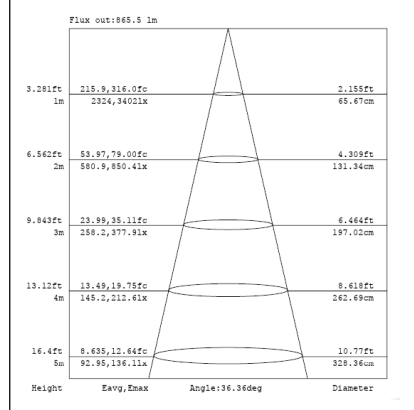
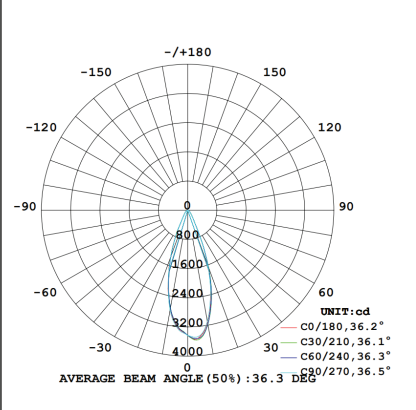

**Packaging:**

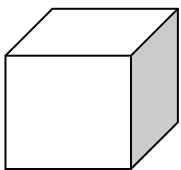

**Box**  
 L135\*W135\*H80mm  
 1pc/box  
 GW: 0.45kg/box

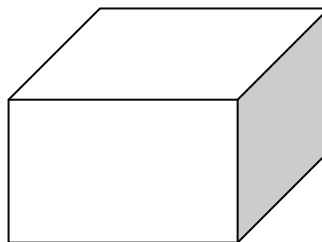

**Outer carton**  
 L560\*W300\*H340mm  
 32pcs/CTN  
 GW: 16kg/carton

Installation instruction

1,Cut Hole

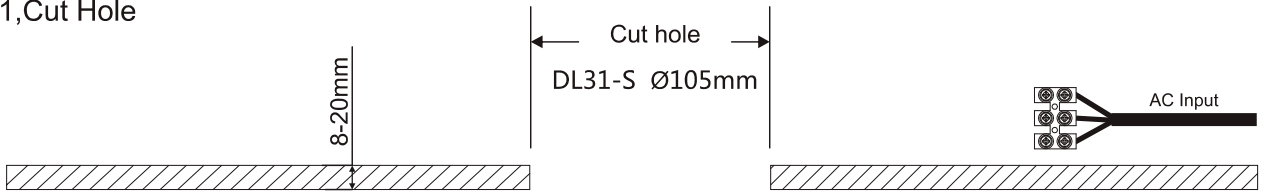

2,Connect Wire

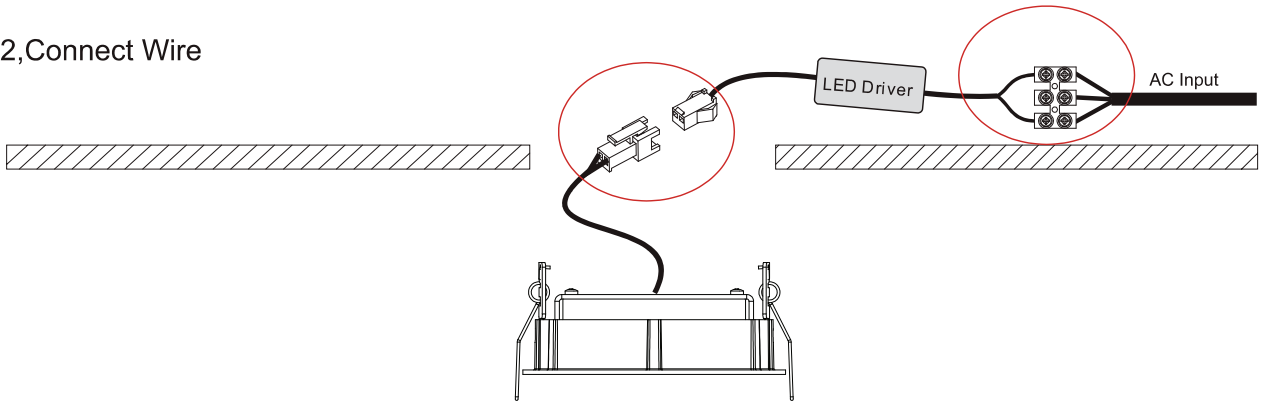

3,Fit the luminaire in the hole

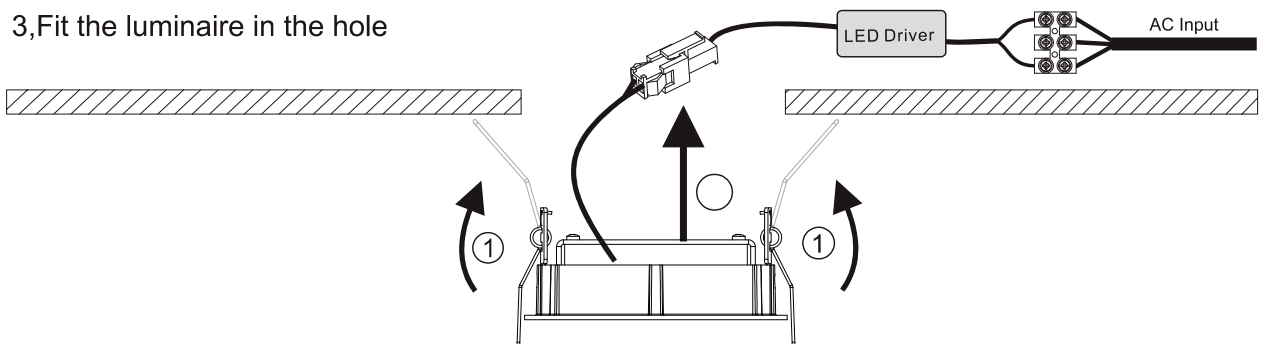

4,Finish

